

ridalco

STAINLESS  
STEEL  
SINKS

# SELF-RIMMING SINKS

## General Specifications

- Sinks are fully-covered and manufactured from 1.6mm (16 ga.) type 304 stainless steel.
- Each sink unit is provided with a 32mm (1¼ in.) perimeter mounting flange and clip supports.
- Crumb-cup style strainer drains are standard on all units. Corner-style drains with standing overflows are available as an option.
- Standard depth for all sink bowls is 305mm (12 in.).
- Partially-radiused (front & back only)  
Sink units with divider – add suffix "RFB" available.

MODEL	BOWLS	BOWL - DIMENSIONS (WIDTH x LENGTH x DEPTH)	OVERALL - DIMENSIONS (WIDTH x LENGTH)
SR1-1824	1	457 x 600 x 305mm 18 x 24 x 12 in.	530 x 680mm 21 x 27 in.
SR1-2020	1	500 x 500 x 305mm 20 x 20 x 12 in.	580 x 580mm 23 x 23 in.
SR1-2030	1	500 x 760 x 305mm 20 x 30 x 12 in.	580 x 840mm 23 x 33 in.
SR1-2424	1	600 x 600 x 305mm 24 x 24 x 12 in.	680 x 680mm 27 x 27 in.
SR2-1824	2	457 x 600 x 305mm 18 x 24 x 12 in.	1300 x 530mm 51 x 21 in.
SR2-2020	2	500 x 500 x 305mm 20 x 20 x 20 in.	1100 x 580mm 43 x 23 in.
SR2-2424	2	600 x 600 x 305mm 24 x 24 x 12 in.	1300 x 680mm 51 x 27 in.
SR3-1616	3	400 x 400 x 305mm 16 x 16 x 12 in.	1300 x 480mm 51 x 19 in.
SR3-1920	3	480 x 500 x 305mm 19 x 20 x 12 in.	1525 x 580mm 60 x 23 in.
SR3-2420	3	600 x 500 x 305mm 24 x 20 x 12 in.	1600 x 680mm 63 x 27 in.

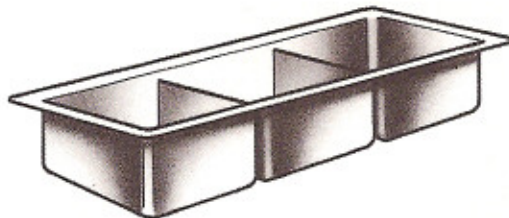
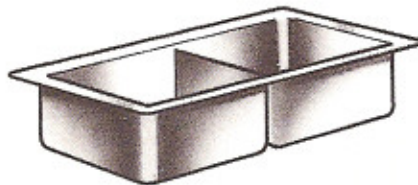
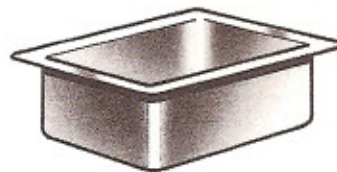

**ridalco**

Ridalco Industries Inc.  
1551 Michael Street  
Ottawa, Ontario K1B 3T4

Tel. (613) 745-9161  
Fax (613) 745-6452  
www.ridalco.com  
info@ridalco.com

# UTILITY SINKS

## General Specifications

- Sink units are manufactured from heavy-duty, 1.6mm (16 ga.) type 304 stainless steel.
- Interior of basin compartments are radiused at front and rear to provide improved drainage and ease in cleaning.
- Galvanized-steel tubular support legs are 41mm (1 $\frac{5}{8}$  in.) diameter complete with adjustable levelling foot.
- Standard 150mm (6 in.) high backsplash is provided

with faucet mounting holes on 200mm (8 in.) centres.

- Each sink basin is equipped with corner drains, standing overflow pipes and perforated stainless steel swill guards as standard equipment.

MODEL	BOWLS	LEFT-RIGHT INTERIOR BOWL DIMENSIONS		FRONT-BACK INTERIOR BOWL DIMENSIONS		LEFT-RIGHT OVERALL EXTERIOR DIMENSIONS		FRONT-BACK OVERALL EXTERIOR DIMENSIONS	
		mm	in.	mm	in.	mm	in.	mm	in.
RUS-1-1818	1	457	18 x 457	18	540	21 $\frac{1}{2}$ x 550	22		
RUS-1-2421	1	600	24 x 530	21	700	27 $\frac{1}{2}$ x 620	24 $\frac{1}{2}$		
RUS-1-3024	1	760	30 x 600	24	850	33 $\frac{1}{2}$ x 700	27 $\frac{1}{2}$		
RUS-1-3624	1	914	36 x 600	24	1000	39 $\frac{1}{2}$ x 700	27 $\frac{1}{2}$		
RUS-1-4824	1	1220	48 x 600	24	1300	51 $\frac{1}{2}$ x 700	27 $\frac{1}{2}$		
RUS-2-3621	2	457	18 x 530	21	1000	39 $\frac{1}{2}$ x 620	24 $\frac{1}{2}$		
RUS-2-4821	2	600	24 x 530	21	1300	51 $\frac{1}{2}$ x 620	24 $\frac{1}{2}$		
RUS-2-5421	2	690	27 x 530	21	1460	57 $\frac{1}{2}$ x 620	24 $\frac{1}{2}$		
RUS-2-6021	2	760	30 x 530	21	1600	63 $\frac{1}{2}$ x 620	24 $\frac{1}{2}$		
RUS-2-6024	2	760	30 x 600	24	1600	63 $\frac{1}{2}$ x 700	27 $\frac{1}{2}$		
RUS-3-4821	3	400	16 x 530	21	1300	51 $\frac{1}{2}$ x 620	24 $\frac{1}{2}$		
RUS-3-5421	3	457	18 x 530	21	1460	57 $\frac{1}{2}$ x 620	24 $\frac{1}{2}$		
RUS-3-6021	3	500	20 x 530	21	1600	63 $\frac{1}{2}$ x 620	24 $\frac{1}{2}$		
RUS-3-6024	3	500	20 x 600	24	1600	63 $\frac{1}{2}$ x 700	27 $\frac{1}{2}$		
RUS-3-7224	3	600	24 x 600	24	1900	75 $\frac{1}{2}$ x 700	27 $\frac{1}{2}$		

ALL SINK UNITS HAVE 330mm (13") DEEP BOWLS

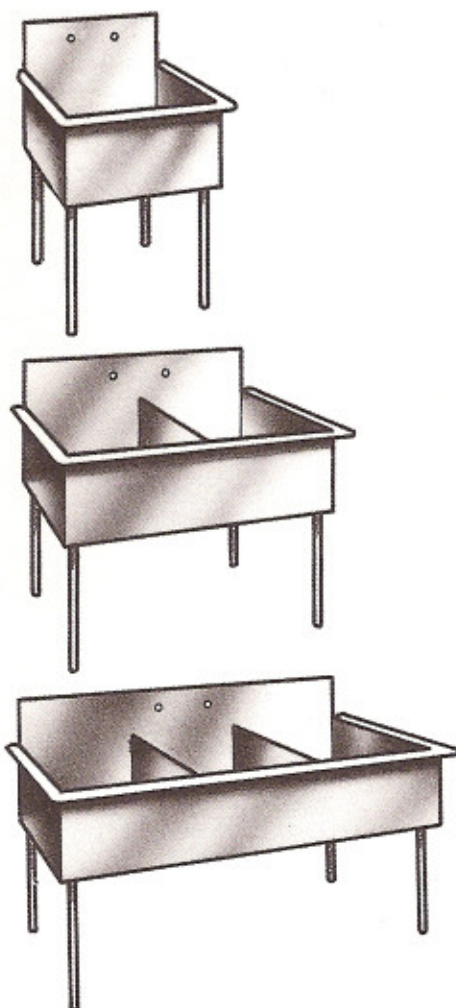

**ridalco**

Ridalco Industries Inc.  
1551 Michael Street  
Ottawa, Ontario K1B 3T4

Tel. (613) 745-9161  
Fax (613) 745-6452  
www.ridalco.com  
info@ridalco.com

# INSTITUTIONAL SINKS

## General Specifications

- Manufactured from extra-heavy duty 2.0mm (14 ga.) type 304 stainless steel.
- All sink units have fully-radiused joints and cover-cornered bowls, integral with top.
- Stainless steel tubular support legs and cross-bracing members are 41mm (1½ in.) diameter. Legs are equipped with adjustable, self-levelling feet.
- Standard 200mm (8 in.) high, splayed backslash is provided with faucet mounting holes on 200mm (8 in.) centres.
- Each sink basin is equipped with corner drains, standing overflow pipes and perforated stainless steel swill guards as standard equipment.
- Individual or double drainboards are available as indicated. Standard sink basin depth is 350mm (14 in.)

MODEL	BOWLS	DRAIN-BOARDS	INTERIOR BASIN DIMENSIONS	LEFT-RIGHT EXTERIOR DIMENSIONS	FRONT-BACK EXTERIOR DIMENSIONS
RC1S-2020	1	left or right	500mm x 500mm 20 in. x 20 in.	1170mm x 760mm 46 in. x 30 in.	
RC1S-2424	1	left or right	600mm x 600mm 24 in. x 24 in.	1170mm x 760mm 46 in. x 30 in.	
RC2S-2020	2	left & right	500mm x 500mm 20 in. x 20 in.	1828mm x 760mm 72 in. x 30 in.	
RC2S-2424	2	left & right	600mm x 600mm 24 in. x 24 in.	2130mm x 760mm 84 in. x 30 in.	
RC2S-2430	2	left & right	600mm x 760mm 24 in. x 30 in.	2740mm x 760mm 108 in. x 30 in.	
RC3S-2020	3	left & right	500mm x 500mm 20 in. x 20 in.	2430mm x 760mm 96 in. x 30 in.	
RC3S-2424	3	left & right	600mm x 600mm 24 in. x 24 in.	2740mm x 760mm 108 in. x 30 in.	
RC3S-2430	3	left & right	600mm x 760mm 24 in. x 30 in.	3040mm x 760mm 120 in. x 30 in.	



**ridalco**

Ridalco Industries Inc.  
1551 Michael Street  
Ottawa, Ontario K1B 3T4

Tel. (613) 745-9161  
Fax (613) 745-6452  
www.ridalco.com  
info@ridalco.com

# DISHTABLING

## General Specifications

- Standard-duty dishtabling shall be manufactured from 1.6mm (16 ga.) type 304 stainless steel. Heavy-duty dishtabling from 2.0 (14 ga.) material.
- Dishtabling shall be provided up to a 760mm (30 in.) depth as standard. Normal integral backsplash height shall be 150mm (6 in.).
- Galvanized-steel, tubular leg supports and/or cross bracing shall be 41mm (1 $\frac{7}{8}$  in.) diameter. Legs shall be equipped with adjustable, self-levelling feet.

- Refer below to available options and accessories for dishtabling.

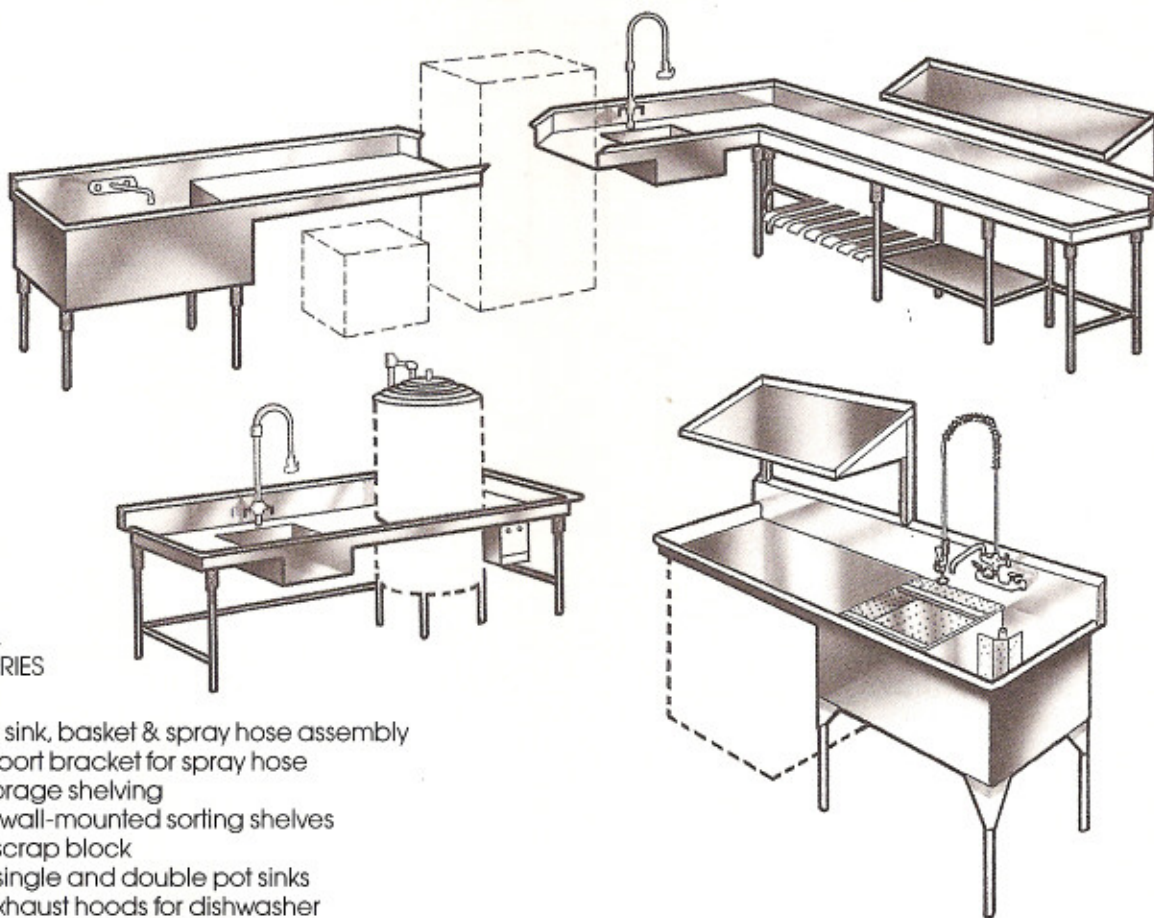

## OPTIONAL ACCESSORIES

- Pre-rinse sink, basket & spray hose assembly
- Wall support bracket for spray hose
- Lower storage shelving
- Slanted, wall-mounted sorting shelves
- Rubber scrap block
- Integral single and double pot sinks
- Steam exhaust hoods for dishwasher
- Stainless steel legs & bracing
- Stainless steel single or double pot sink

\* specifications subject to change without notice.

**ridalco**

Ridalco Industries Inc.  
1551 Michael Street  
Ottawa, Ontario K1B 3T4

Tel. (613) 745-9161  
Fax (613) 745-6452  
www.ridalco.com  
info@ridalco.com

# ECONOMY SINKS

Sink units are manufactured  
 from 1.2mm (18 ga)  
 type 304 stainless steel  
 Galvanized steel tubular legs  
 Centre drain fittings standard  
 Corner drain fittings optional

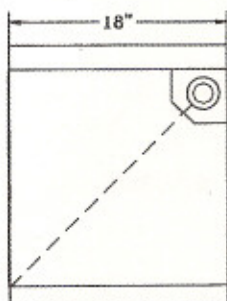

Model # EC1-18/1  
 (shown with optional corner drains)

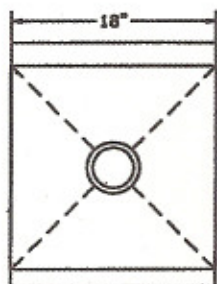

Model # EC1-18/1

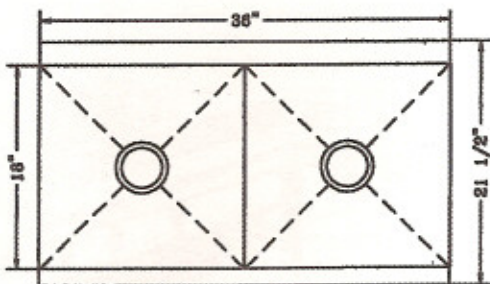

Model # EC2-36/2

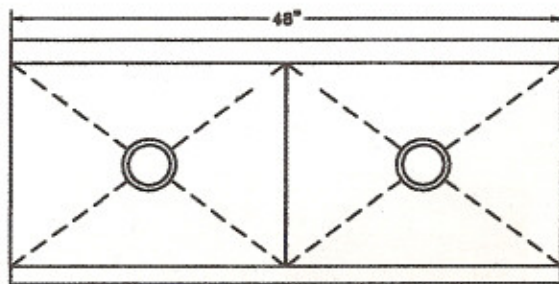

Model # EC2-48/2

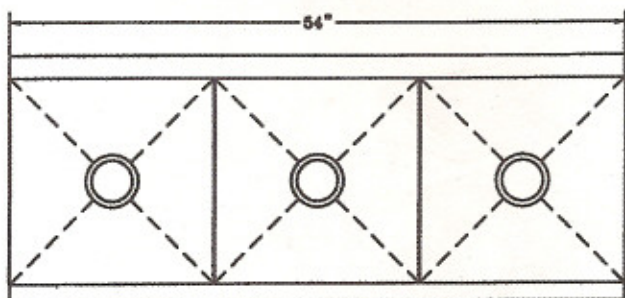

Model # EC3-54/3

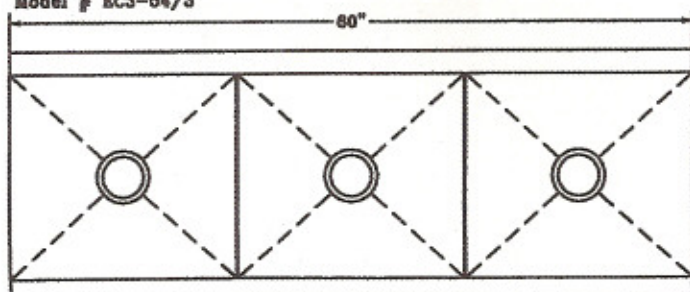

Model # EC3-80/3

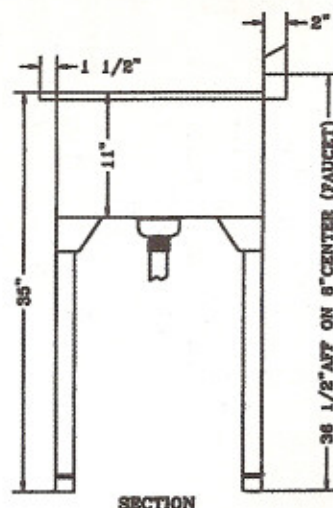

# ECONOMY DISHTABLING

## ECONOMY DISHTABLES!

Reversible "Super-Eco"

Straight-Thru Economy Dishtables

16 GA. S/S Top on Galv "H" Leg/Brace Frame

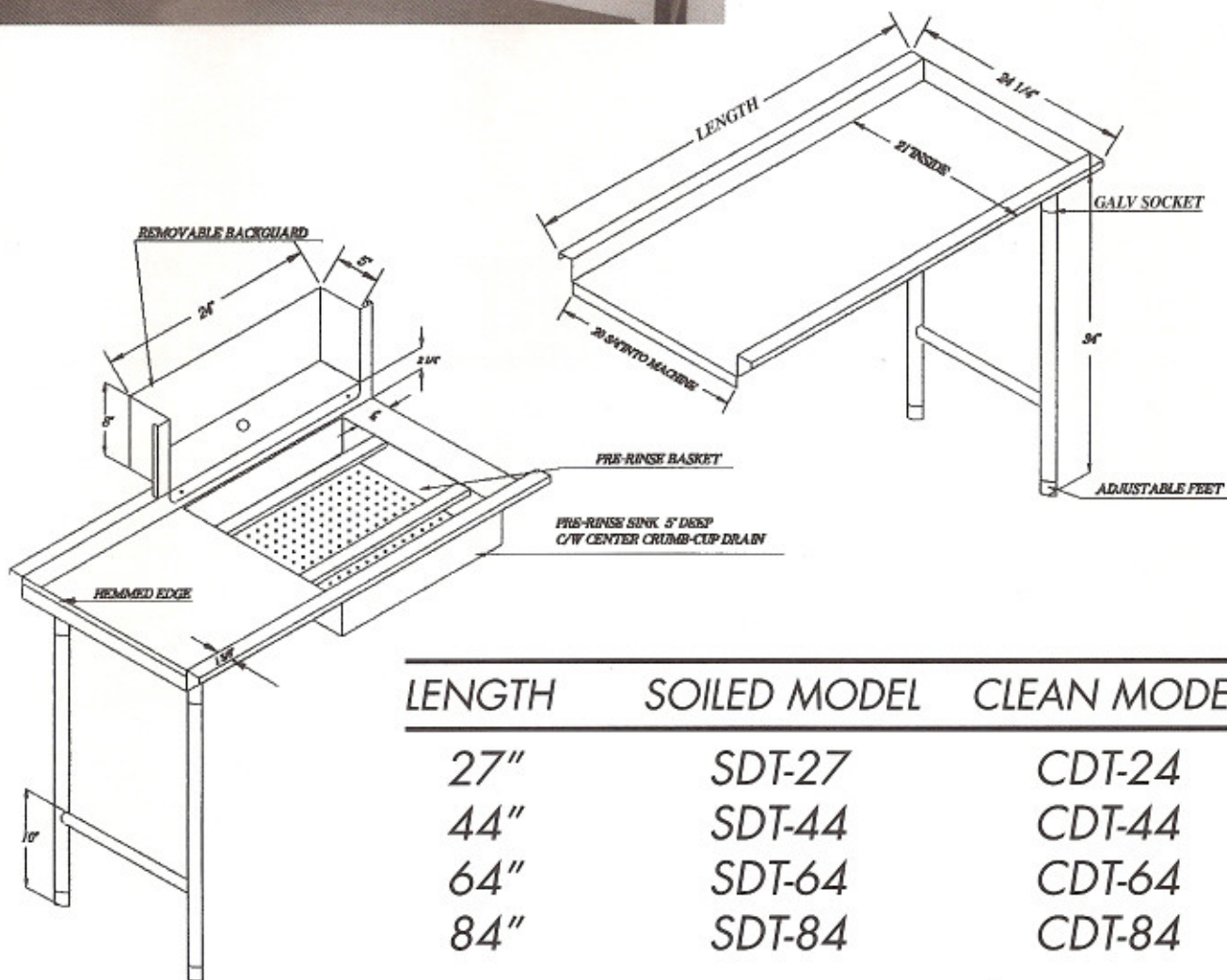
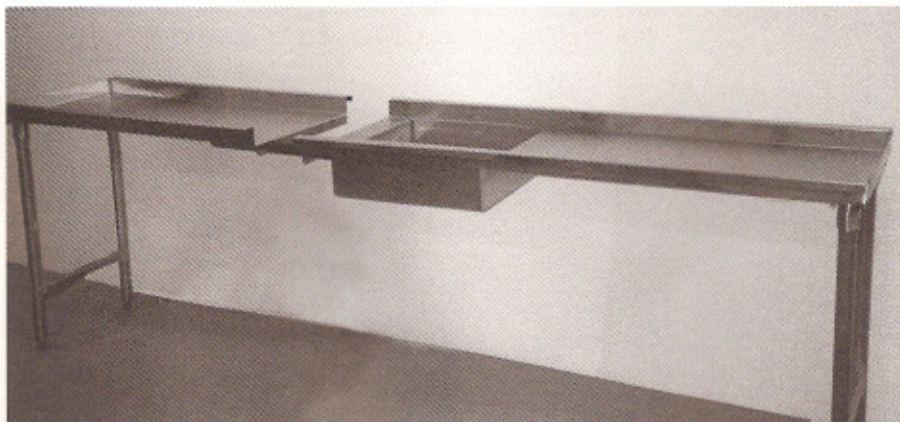

LENGTH	SOILED MODEL	CLEAN MODEL
27"	SDT-27	CDT-24
44"	SDT-44	CDT-44
64"	SDT-64	CDT-64
84"	SDT-84	CDT-84

**ridalco**

Ridalco Industries Inc.  
1551 Michael Street  
Ottawa, Ontario K1B 3T4

Tel. (613) 745-9161  
Fax (613) 745-6452  
www.ridalco.com  
info@ridalco.com

# MOBILE SINKS

## General Specifications

- Fully-covered sink basin manufactured from 1.6mm (16 ga.) type 304 stainless steel.
- Rolled-rim safety edge perimeter on sink basin is standard.
- Stainless steel tubular support legs, 41mm (1 5/8") diameter, are equipped with 100mm (4") diameter all-

swivel casters. Legs are secured to sink basin by extended, reinforced, stainless steel gussets.

- Sink basin is provided with a lever-action release drain having an extended tail-piece for ease in draining.

MODEL	BOWLS	LEFT-RIGHT INTERIOR BASIN	FRONT-BACK EXTERIOR DIMENSIONS
RMSS-2222	1	560mm x 560mm 22 in. x 22 in.	635mm x 635mm 25 in. x 25 in.
RMSS-2228	1	560mm x 700mm 22 in. x 28 in.	635mm x 790mm 25 in. x 31 in.
RMSS-3030	1	760mm x 760mm 30 in. x 30 in.	840mm x 840mm 33 in. x 33 in.
RMSS-3030-H	1	760mm x 760mm 30 in. x 30 in.	840mm x 840mm 33 in. x 33 in.



# OPTIONS AND ACCESSORIES

- DRAINBOARDS** Counter-style, up to 600mm (24 in.) square in size  
HSD removeable, for use with RUS series sinks, up to 600mm (24 in.) in length  
DW permanent, for use with RUS series sinks, integrally-welded, up to 600mm (24 in.)  
Removeable sink cover (per basin)
- DRAIN FITTINGS** Corner-style drain c/w tailpiece  
Chrome-plated or stainless steel overflow standpipe  
Basket-style crumb-cup strainer (type 304 or 316 s/s)  
Lever or twist handle drain: overflow assembly optional
- FAUCET ACCESSORIES** Deck-style, bar-type c/w gooseneck spout  
Deck-style, c/w swing spout up to 305mm (12 in.) long  
Wall-style, standard or deluxe heavy-duty, c/w swing spout up to 305mm (12 in.) long  
Deck-style, pre-rinse spray assembly with s/s hose

- GENERAL OPTIONS** Undercoating for self-rim sinks  
Exterior bowl polishing on self-rim sinks  
Corner Bumpers for mobile soak sinks  
Stainless steel legs and feet

